

Answers to

- | | | | |
|-----------------------------|-----------------------------|-----------------------------|------------------------------|
| 1) 600 in ³ | 2) 1000 m ³ | 3) 3 cm ³ | 4) 567 km ³ |
| 5) 175 m ³ | 6) 640 yd ³ | 7) 90 ft ³ | 8) 500 yd ³ |
| 9) 576 m ³ | 10) 36 mi ³ | 11) 252 km ³ | 12) 140 yd ³ |
| 13) 12 mi ³ | 14) 168 cm ³ | 15) 63 yd ³ | 16) 363 yd ³ |
| 17) 9 cm ³ | 18) 270 in ³ | 19) 660 mi ³ | 20) 440 ft ³ |
| 21) 168 yd ³ | 22) 86 in ³ | 23) 48 km ³ | 24) 248.4 cm ³ |
| 25) 192 cm ³ | 26) 242 cm ³ | 27) 24 in ³ | 28) 264 cm ³ |
| 29) 144 cm ³ | 30) 120 cm ³ | 31) 4976.28 ft ³ | 32) 3041.06 yd ³ |
| 33) 1206.37 in ³ | 34) 2827.43 cm ³ | 35) 125.66 cm ³ | 36) 1526.81 ft ³ |
| 37) 2280.8 yd ³ | 38) 3455.75 m ³ | 39) 804.25 yd ³ | 40) 2513.27 yd ³ |
| 41) 94.25 m ³ | 42) 20.94 ft ³ | 43) 1526.81 m ³ | 44) 37.7 cm ³ |
| 45) 3619.11 ft ³ | 46) 2094.4 in ³ | 47) 9.42 m ³ | 48) 261.8 km ³ |
| 49) 1072.33 ft ³ | 50) 10.47 yd ³ | 51) 1436.76 yd ³ | 52) 179.59 km ³ |
| 53) 3053.63 km ³ | 54) 2572.44 in ³ | 55) 2065.24 mi ³ | 56) 7238.23 ft ³ |
| 57) 268.08 mi ³ | 58) 3942.46 ft ³ | 59) 2952.97 in ³ | 60) 4188.79 mi ³ |
| 61) 149.33 mi ³ | 62) 234.67 mi ³ | 63) 9 yd ³ | 64) 170.67 in ³ |
| 65) 2.67 mi ³ | 66) 213.33 km ³ | 67) 41.67 yd ³ | 68) 60 cm ³ |
| 69) 6 km ³ | 70) 366.67 cm ³ | 71) 210 ft ³ | 72) 96 mi ³ |
| 73) 2787.64 in ³ | 74) 25.13 cm ³ | 75) 216 cm ³ | 76) 972 ft ³ |
| 77) 125.66 ft ³ | 78) 2144.66 km ³ | 79) 54 ft ³ | 80) 12 mi ³ |
| 81) 9 in ³ | 82) 448 ft ³ | 83) 322.67 cm ³ | 84) 4976.28 yd ³ |
| 85) 91.67 mi ³ | 86) 333.04 cm ³ | 87) 7.33 in ³ | 88) 1526.81 km ³ |
| 89) 75.4 km ³ | 90) 50 m ³ | 91) 264 cm ³ | 92) 1781.28 mi ³ |
| 93) 300 yd ³ | 94) 400 m ³ | 95) 252 yd ³ | 96) 12 cm ³ |
| 97) 523.6 m ³ | 98) 2280.8 yd ³ | 99) 80 mi ³ | 100) 72 km ³ |
| 101) 432 cm ³ | 102) 5.33 cm ³ | 103) 113.1 yd ³ | 104) 20 ft ³ |
| 105) 5575.28 m ³ | 106) 718.38 yd ³ | 107) 15 mi ³ | 108) 194.4 in ³ |
| 109) 235.62 yd ³ | 110) 3053.63 m ³ | 111) 600 ft ³ | 112) 2147.76 m ³ |
| 113) 901.97 cm ³ | 114) 1323 in ³ | 115) 539 mm ³ | 116) 3663.33 cm ³ |
| 117) 2754 m ³ | 118) 339.36 in ³ | 119) 904.32 cm ³ | 120) 5849.82 in ³ |
| 121) 416.52 cm ³ | 122) 312 mm ³ | 123) 776 mm ³ | 124) 736.85 in ³ |
| 125) 976.95 m ³ | 126) 4082 cm ³ | 127) 108.85 m ³ | 128) 396 ft ³ |
| 129) square prism | 130) triangular prism | 131) triangular prism | 132) triangular prism |
| 133) rectangular prism | 134) square pyramid | 135) cylinder | 136) cone |
| 137) | 138) | 139) | |

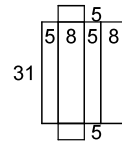

140)

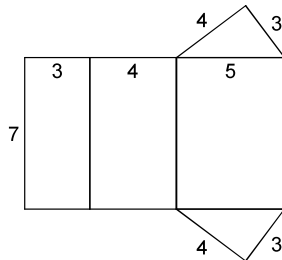
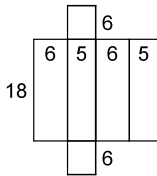
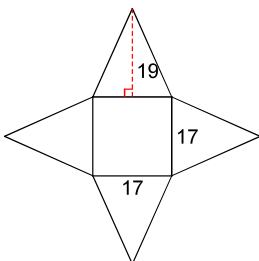

141)

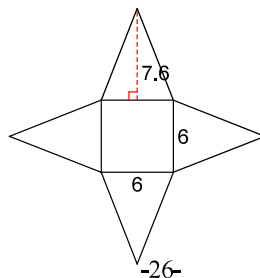

142)

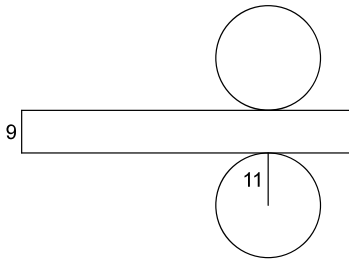

143)

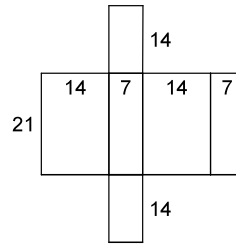

144)

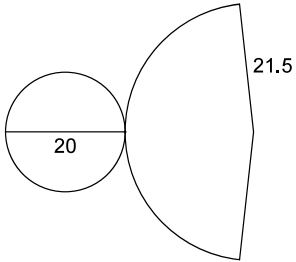

145)

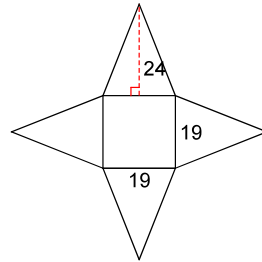

146)

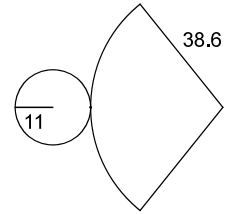

147)

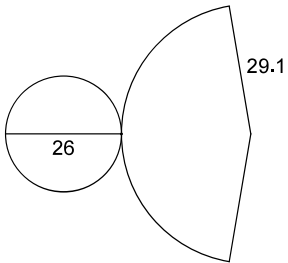

148)

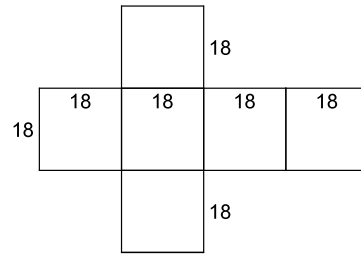

149)

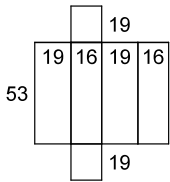

150)

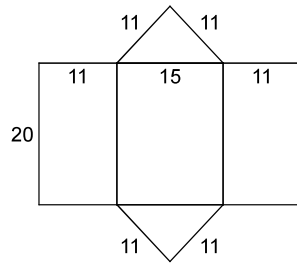

151)

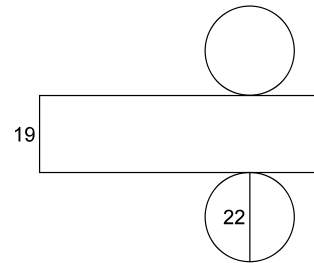

152)

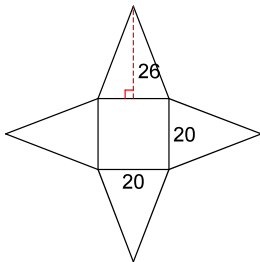

153)

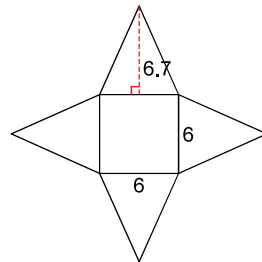

154)

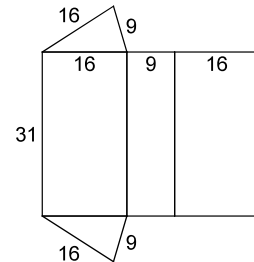

155)

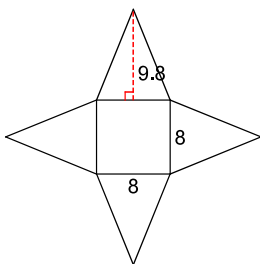

156)

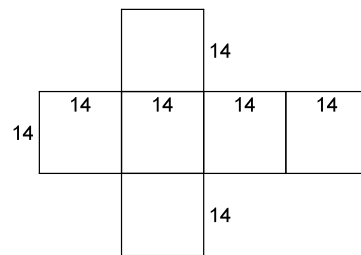

157)

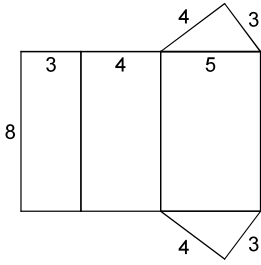

158)

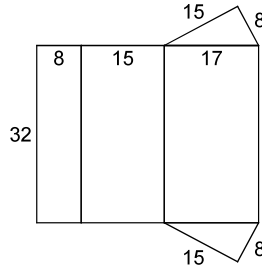

159)

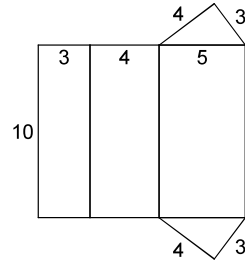

160)

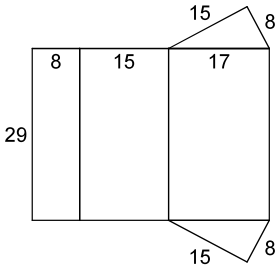

161)

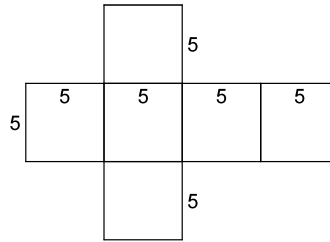

162)

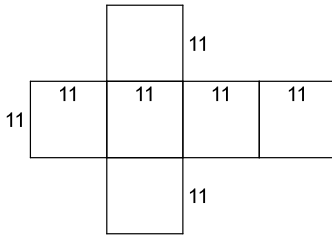

163)

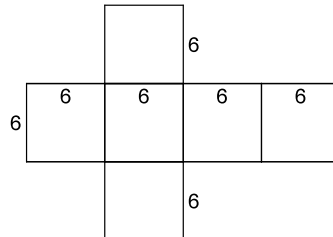

164)

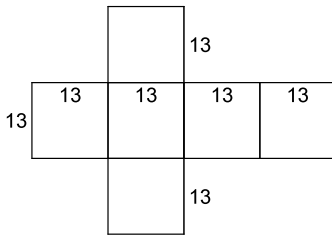

165)

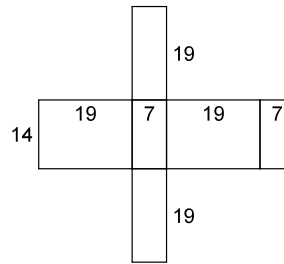

166)

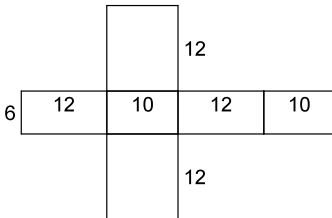

167)

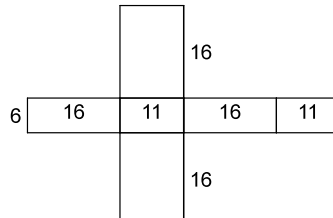

168)

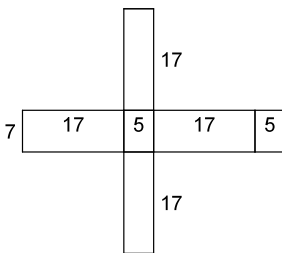

169)

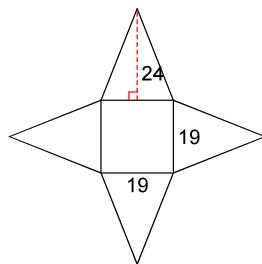

170)

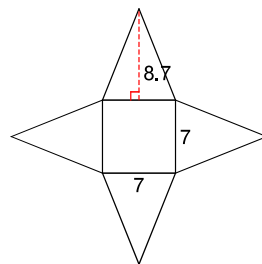

171)

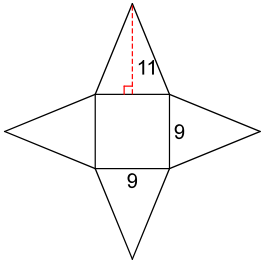

172)

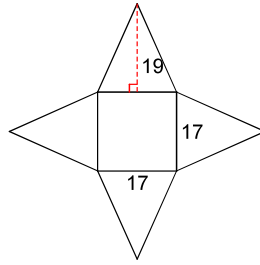

173)

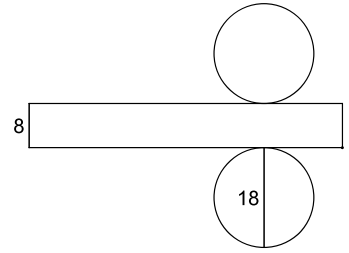

174)

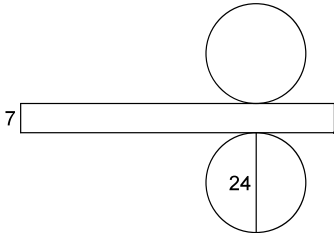

175)

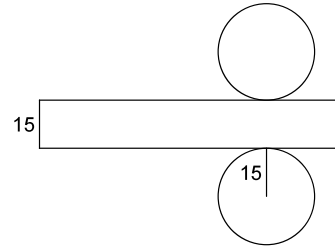

176)

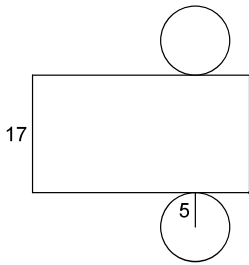

177)

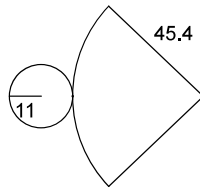

178)

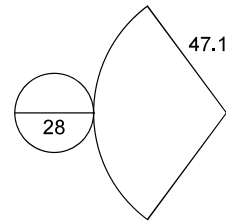

179)

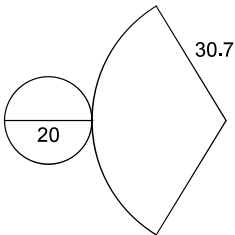

180)

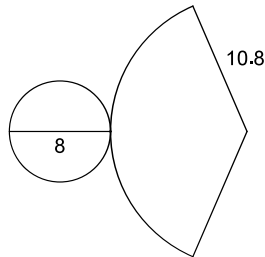

181)

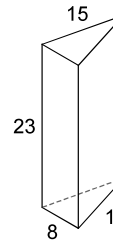

182)

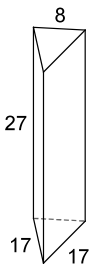

183)

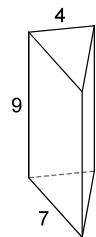

184)

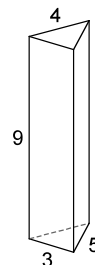

185)

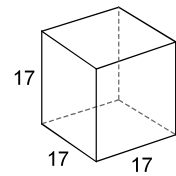

186)

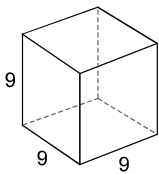

187)

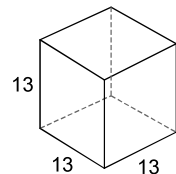

188)

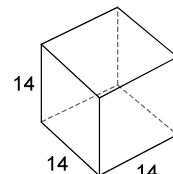

189)

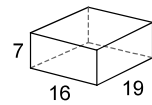

190)

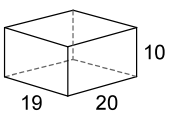

191)

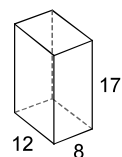

192)

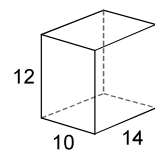

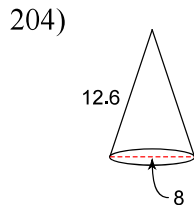
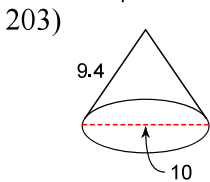
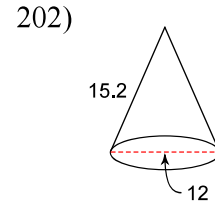
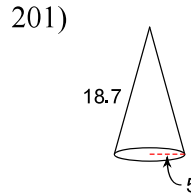
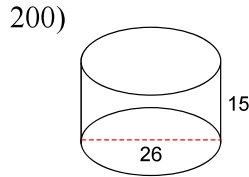
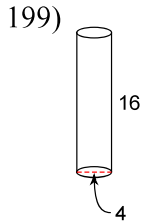
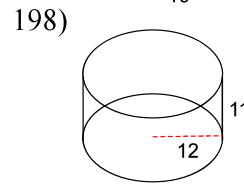
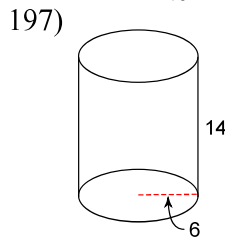
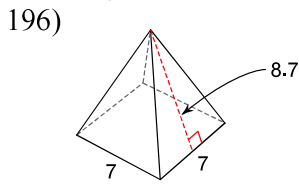
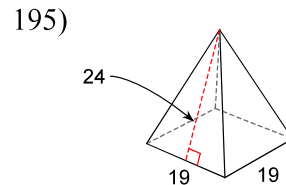
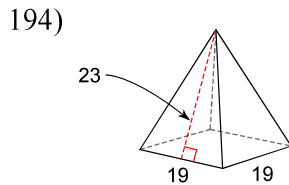
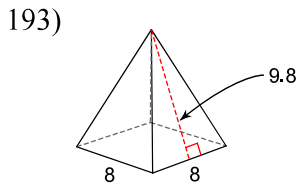

205) 120 km²

206) 192 ft²

207) 168 km²

208) 144 cm²

209) 60 in²

210) 187 yd²

211) 144 cm²

212) 84 ft²

213) 124.8 ft²

214) 240 cm²

215) 506 mi²

216) 672 ft²

217) 90 mi²

218) 576 yd²

219) 450 ft²

220) 680 ft²

221) 726 m²

222) 290 mi²

223) 32 mi²

224) 288 cm²

225) 442 ft²

226) 472 m²

227) 286 cm²

228) 352 m²

229) 142 m²

230) 206 yd²

231) 478 mi²

232) 426 mi²

233) 192 m²

234) 136 m²

235) 444 cm²

236) 384 km²

237) 251.2 cm²

238) 166.4 m²

239) 197.4 ft²

240) 364.8 cm²

241) 59.2 ft²

242) 116.4 km²

243) 150 ft²

244) 411.4 m²

245) 1432.57 ft²

246) 640.88 cm²

247) 150.8 m²

248) 163.36 yd²

249) 245.04 mi²

250) 408.41 in²

251) 414.69 in²

252) 263.89 km²

253) 904.78 m²

254) 125.66 in²

255) 822.78 ft²

256) 10.05 in²

257) 82.94 in²

258) 76.65 ft²

259) 1462.73 cm²

260) 254.47 yd²

261) 365.68 cm²

262) 499.2 yd²

263) 1017.88 km²

264) 1230.25 mi²

265) 201.06 cm²

266) 12.57 ft²

267) 36.32 m²

268) 1017.88 m²

269) 113.1 m²

270) 1520.53 m²

271) 804.25 km²

272) 1809.56 cm²

273) 50.27 ft²

274) 314.16 m²

275) 56 in²

276) 112 yd²

277) 320 ft²

278) 336 km²

279) 586 cm²

280) 48 mi²

281) 340 yd²

282) 636 m²

283) 471.24 ft²

284) 1357.17 mi²

285) 78.54 km²

286) 822.78 in²

287) 358 in²

288) 374 cm²

289) 62.83 ft²

290) 1583.36 ft²

291) 162 in²

292) 192 km²

293) 1017.88 ft²

294) 127.2 mi²

295) 144 cm²

296) 414 in²

297) 724 in²

298) 125.66 m²

299) 254.8 km²

300) 30 yd²

301) 376.99 in²

302) 36.32 km²

303) 126 km²

304) 1462.73 m²

305) 650.94 yd²

306) 191.13 yd²

307) 1005.31 km²

308) 548 mi²

309) 131.95 km²

310) 160 ft²

311) 929.41 km²

312) 94 cm²

313) 352 mi²

314) 448 cm²

Answer Key

Find the surface area of each figure. Round the answer to two decimal places. (use $\pi = 3.14$)

1)

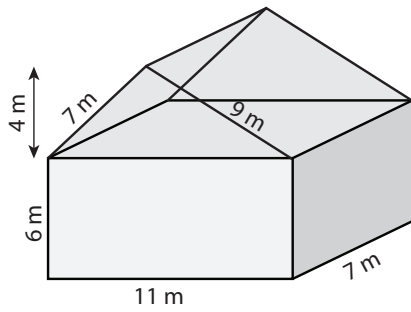

Surface Area = 493 m²

2)

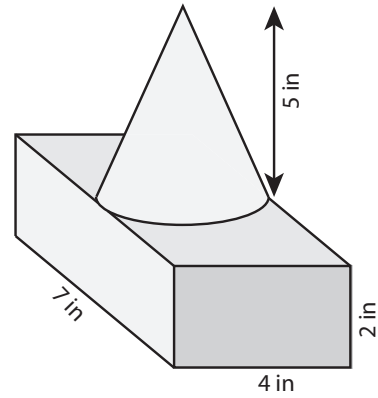

Surface Area = 121.29 in²

3)

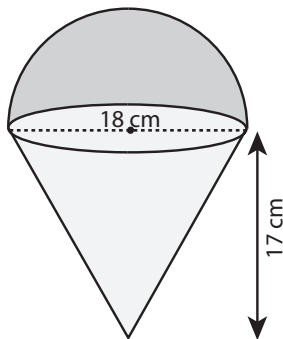

Surface Area = 1052.40 cm²

4)

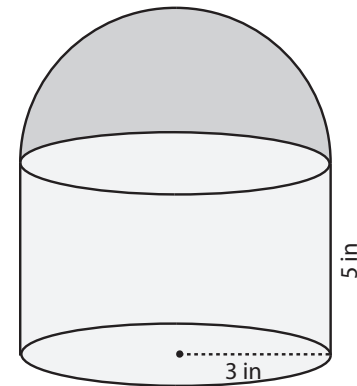

Surface Area = 178.98 in²

5)

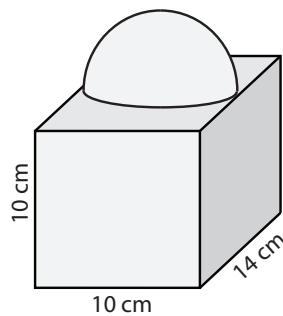

Surface Area = 838.5 cm²

6)

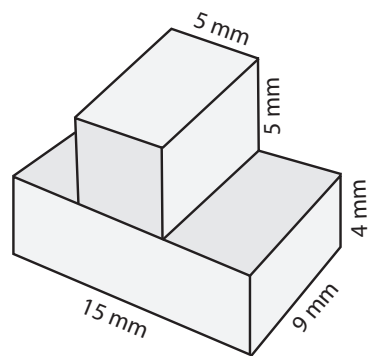

Surface Area = 602 mm²

Answer Key

Find the surface area of each figure. Round the answer to two decimal places. (use $\pi = 3.14$)

1)

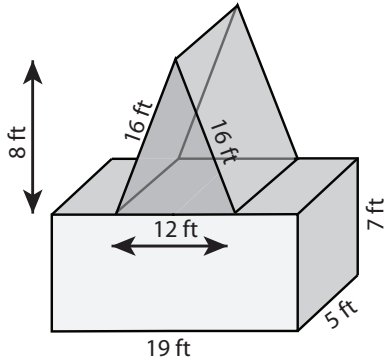

Surface Area = 722 ft²

2)

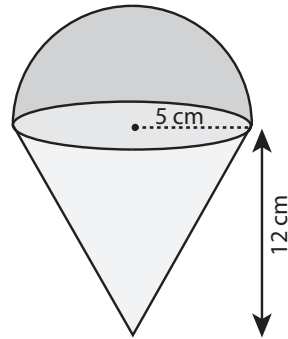

Surface Area = 361.1 cm²

3)

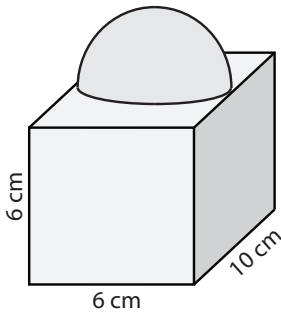

Surface Area = 340.26 cm²

4)

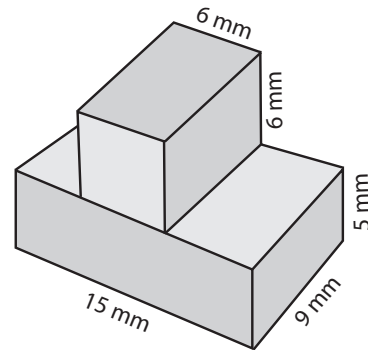

Surface Area = 690 mm²

5)

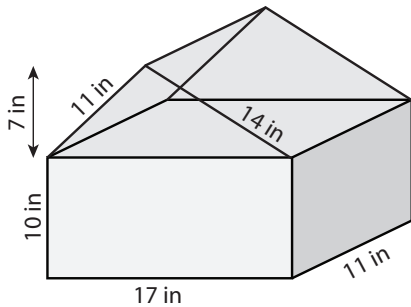

Surface Area = 1174 in²

6)

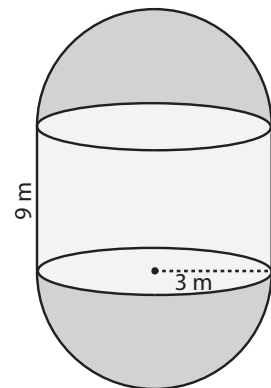

Surface Area = 282.6 m²